

SLIDING PILLARS | SCHIEBERUNGEN

Technical manual - Technische Anleitung



E|D

THE SKY IS NOT THE LIMIT

CONTENT

SESAM Sliding pillars

SAFE PILLAR LP2	4
Parts and structure	5
Basic elements LP2 pillar	5
Parts and articlenumbers	6
Visual difference between standard base and base Code XL	7
LIGHT PILLAR LP3	8
Parts and structure	9
Basic elements LP3 pillar	9
Parts and articlenumbers	10

INHALT

SESAM Schieberungen

SAFE PILLAR LP2	4
<i>Teilen und Aufbau</i>	5
<i>Basisteile LP2 Runge</i>	5
<i>Teilen und Artikelnummer</i>	6
<i>Visueller Unterschied zwischen standard Basis und Basis Code XL</i>	7
LIGHT PILLAR LP3	8
<i>Teilen und Aufbau</i>	9
<i>Basisteile LP2 Runge</i>	9
<i>Teilen und Artikelnummer</i>	10

SAFE PILLAR LP2

Standard sliding pillar

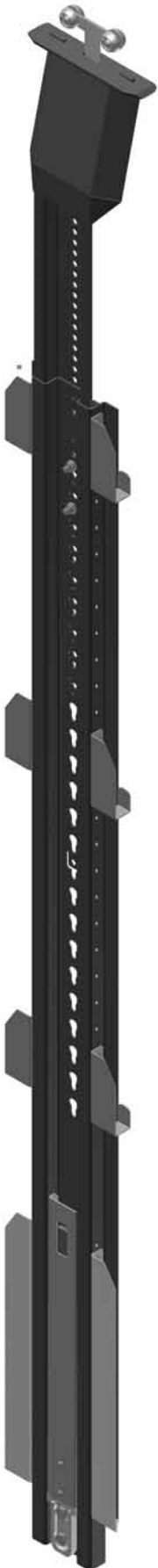

Features and advantages

- 2 versions available:
 - LP2 Standard version: EN12642
Strong: tested with > 700 daN
 - LP2 version Code XL: EN 12642 XL
Extra strong: tested with > 1250 daN
- Minimum height: 2350mm
- Average weight: 27 Kg
- Weight base: 18 Kg
- Multifunctional base
- 2 types top pieces available:
 - Top piece with length 1200mm:
length pillar: 2350mm - 2800mm (\pm 27 Kg)
 - Top piece with length 1700mm:
length pillar: 2810mm - 3000mm (\pm 31 Kg)

Section

Rungen Querschnitt

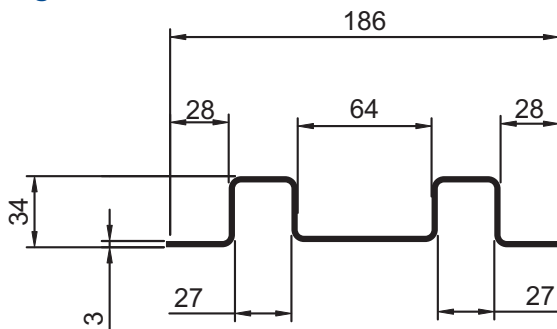

Certified pillar EN 12642 XL

Safe-Pillar LP-2 is certified by Dekra:

- certificate nr: **313 / 11068 YF 1104752944**
- certificate for: **1.250daN**
- breaking point: > **1.500daN**

Zertifizierte Runge EN 12642 XL

Safe-Pillar LP-2 ist zertifiziert durch Dekra:

- Zertifikat Nr: **313 / 11068 YF 1104752944**
- Zertifikat für: **1.250daN**
- Bruchlast: > **1.500daN**

This ultralight pillar can be used for all purposes:

- Standard pillar - EN 13642
- Certified pillar - EN 13642 XL
- Elevation (telescopic)
- Second floor (Allsafe Jungfalk)
- Timberholders
- Pillar for sideboards

Ausführungen und Vorzüge

- 2 versies beschikbaar:
 - LP2 Standard Version: EN12642
Stark: Getestet mit > 700 daN
 - LP2 Version Code XL: EN 12642 XL
Extra stark: Getestet mit > 1250 daN
- Minimum höhe: 2350mm
- Gemittelt Gewicht: 27 Kg
- Gewicht basis: 18 Kg
- Multifunktionelle Basisrunge
- 2 Versionen Kopfstück verfügbar:
 - Kopfstück mit Länge 1200mm:
Länge Runge: 2350mm - 2800mm (\pm 27 Kg)
 - Kopfstück mit Länge 1700mm:
Länge Runge: 2810mm - 3000mm (\pm 31 Kg)



Die ultra leichte Runge kann für verschiedene Ziele benutzt werden:

- Standard Runge - EN 13642
- Zertifizierte Runge - EN 13642 XL
- Hubrunge (teleskopisch)
- Zweiten Ladenboden (Allsafe Jungfalk)
- Lattentaschen
- Runge für Bordwand

SAFE PILLAR LP2

Standard Schieberung

Parts and structure Teilen und Aufbau

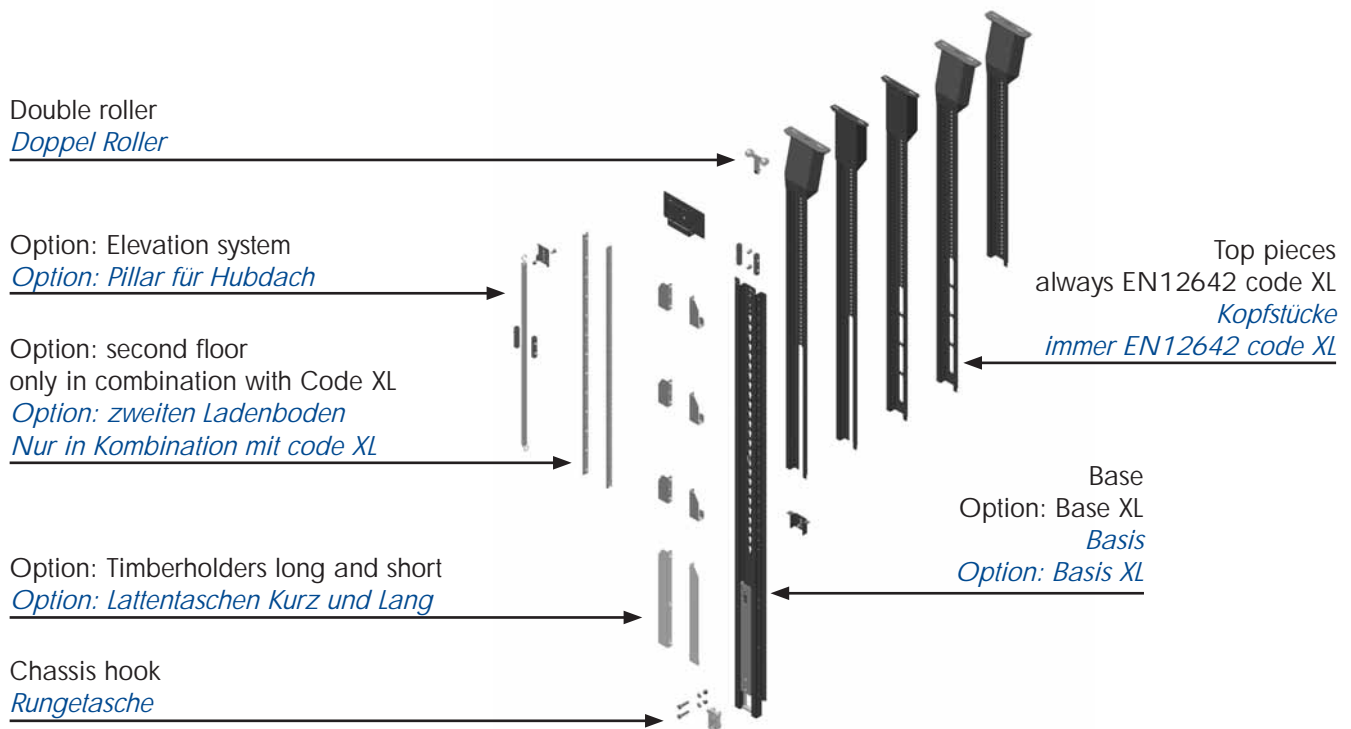

Basic elements LP2 pillar Basisteile LP2 Runge

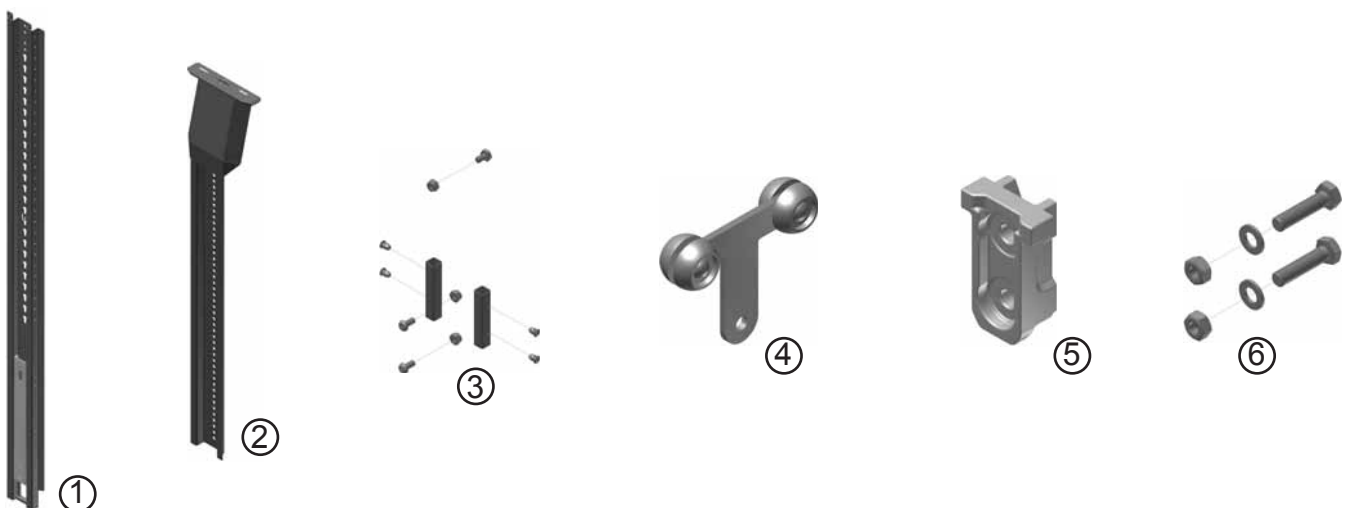

Basic elements LP2 pillar | Basisteile LP2 Runge

Description Umschreibung	Art. Nr.
1 Base LP2 - EN 12642 Basis LP2 - EN 12642	2802.001.1
2 Top piece Kopfstück	depends on the alu rail* abhängig alu Schiene*
3 Mounting kit for top piece Montagesatz für Kopfstück	2801.029.1
4 Double roller Doppel Roller	depends on the alu rail* abhängig alu Schiene*
5 Chassishook Rungetasche	2801.010.1
6 Mounting kit for chassishook Montagesatz für Rungetasche	2801.011.1

(*) see page 5 - *Sehe Pagina 5*

SAFE PILLAR LP2

Standard sliding pillar

Parts and articlenumbers
Teilen und Artikelnummer

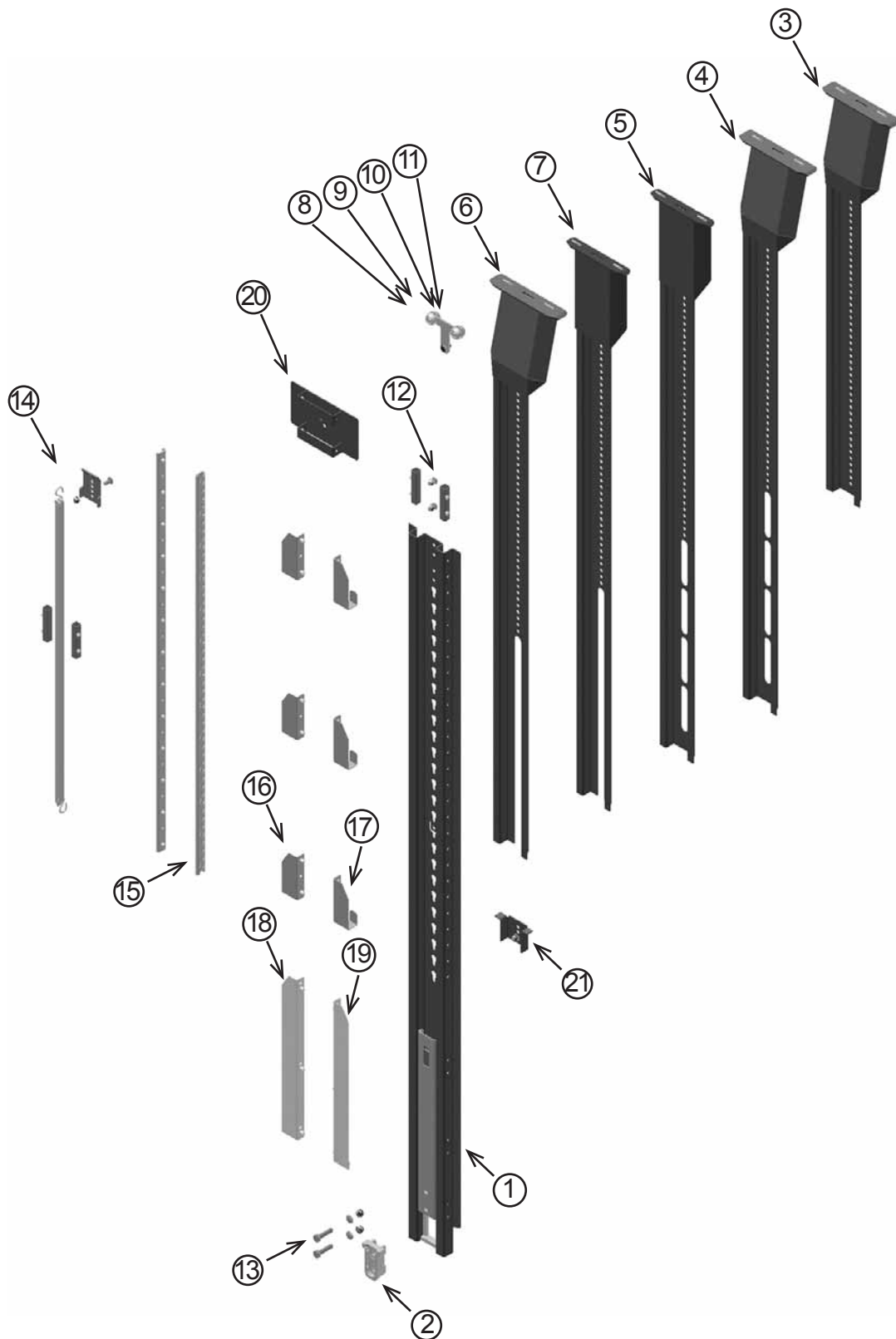

SAFE PILLAR LP2

Standard Schieberunge

Basic elements LP2 - Safe Pillar | Basisteile LP2 - Safe Pillar

Nr	Art. Nr.	Description Umschreibung
1	2802.001.1	SAFE PILLAR LP2 standard <i>SAFE PILLAR LP2 Standard</i>
	2801.001.1	SAFE PILLAR LP2 code XL <i>SAFE PILLAR LP2 code XL</i>
2	2801.010.1	Chassishook LP2 <i>Rungetasche LP2</i>
3	2801.028.2	Top piece LP2 1200/45 certified <i>Kopfstücke LP2 1200/45 zertifiziert</i>
4	2801.021.2	Top piece LP2 1700/45 certified <i>Kopfstücke LP2 1700/45 zertifiziert</i>
5	2801.023.2	Top piece LP2 1700/0 certified <i>Kopfstücke LP2 1700/0 zertifiziert</i>
6	2801.030.2	Top piece LP2 1700/45 elevation + second floor <i>Kopfstücke LP2 1700/45 Hubsystem + Zweiten Ladenboden</i>
7	2801.031.2	Top piece LP2 1700/0 elevation + second floor <i>Kopfstücke LP2 1700/0 lift + Zweiten Ladenboden</i>
8	9000.055.1	Double roller LP2/Multiliner Mix <i>Doppel Roller LP2/Multiliner Mix</i>
9	9000.056.1	Double roller LP2/Multiliner Combi & Slimliner - 20mm <i>Doppel Roller LP2/Multiliner Combi & Slimliner - 20mm</i>
10	9000.057.1	Roller LP2 50/40 <i>Roller LP2 50/40</i>
11	9000.058.1	Roller LP2 - 30mm/Multiliner High <i>Roller LP2 - 30mm/ Multiliner High</i>
12	2801.029.1	Mounting kit top stuk LP2 <i>Montagesatz Kopfstücke LP2</i> <i>3x round head screw M10 x 25 8.8 ISO 7380 3x Bolzkopf Schraube M10 x 25 8.8 ISO 7380</i> <i>3x hexagon nut M10 8 DIN 985 3x hexagon Mutter M10 8 DIN 985</i> <i>2x tube 20 2x Rohr 20</i> <i>4x monobolt rivet 6,4x23,7 4x monobolt Blindniete 6,4x23,7</i>
13	2801.011.1	Screw kit chassishook LP2 <i>Schraubensatz Rungetasche LP2</i> <i>2x hexagon M12x50 10.9 DIN 931 Dacromet 2x hexagon M12x50 10.9 DIN 931 Dacromet</i> <i>2x washer 13 DIN 125-A 2x Scheibe 13 DIN 125-A</i> <i>2x nut M12 8,8 DIN 980 Dacromet 2x Mutter M12 8,8 DIN 980 Dacromet</i>

Options LP2 - Safe Pillar | Option LP2 - Safe Pillar

Nr	Art. Nr.	Description Umschreibung
14	2801.040.1	Elevation kit LP2 <i>Hubrungsatz LP2</i> <i>4x Monobolt rivet 6,4x23,7 4x Monobolt Blindniete 6,4x23,7</i> <i>2x tube 20 2x Rohr 20</i> <i>1x elastic (Crochet S incl.) 1x Gummi (Crochet S incl.)</i> <i>1x steel plate 1x Stahl Platte</i>
15	2801.025.1	Kit second floor (only in combination with code XL) <i>Zweiten Ladenboden (Nur in Kombination mit code XL)</i> <i>2x AJ-System rail staal 1246 2x AJ-System rail staal 1246</i> <i>26x Monobolt rivet 6,4mm galvanized 26x Monobolt Blindniete 6,4mm verzinkt</i>
16	2900.063.2	Timberholder left <i>Rungetasche links</i>
17	2900.064.2	Timberholder right <i>Rungetasche rechts</i>
18	2900.067.2	Timberholder left 500mm <i>Rungetasche links 500mm</i>
19	2900.068.2	Timberholder right 500mm <i>Rungetasche rechts 500mm</i>
20	2801.060.2	Timberholder fixation plate top piece <i>Rungetasche Befestigungsplatte Kopfstück</i>
21	2801.061.1	Height controller <i>Höhe Regulator</i>

Alternatives LP2 - Safe Pillar | Alternative LP2 - Safe Pillar

Art. Nr.	Description Umschreibung
2900.061.2	Timberholder Monobolt 600mm/large - left <i>Rungetasche Monobolt 600mm/groß - links</i>
2900.062.2	Timberholder Monobolt 600mm/large - right <i>Rungetasche Monobolt 600mm/groß - rechts</i>

Visual difference between standard base and base XL Visueller Unterschied zwischen standard Basis und Basis XL

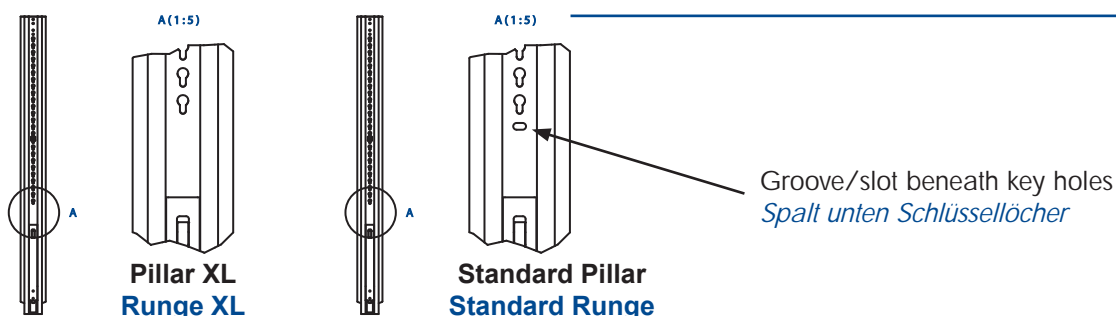

LIGHT PILLAR LP3

Ultra light sliding pillar



Features and advantages

- Maximum height: 3m
- Weight of base: 17,8 Kg
- Optimized grip function
- User-friendly handle
- Simple mounting

Ausführungen und Vorzüge

- *Max. lichte Einbauhöhe: 3m*
- *Gewicht Basis: 17,8 Kg*
- *Optimierte Hebefunktion*
- *Bedienerfreundlicher Handgriff*
- *Einfache Montage*

Section Rungen Querschnitt

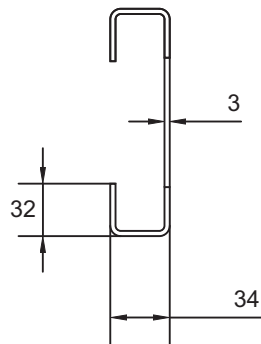

Maximum elevation height Maximum Hubweg der Mechanik

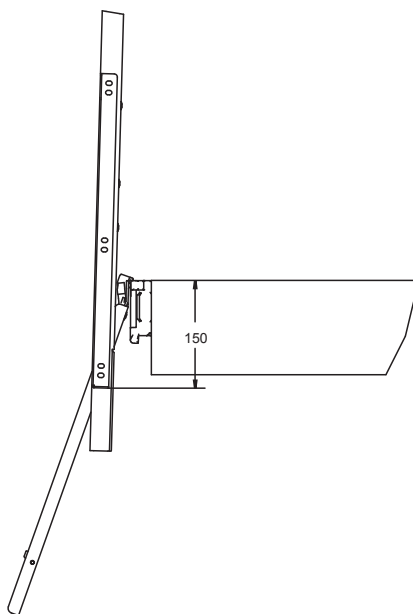

- Lifting Height handle: 150 mm
- Second safety device in handle

- *Hubweg Handhebel: 150 mm*
- *Zweite Sicherung in Handhebel*

LIGHT PILLAR LP3

Ultra leichte Schieberung

Parts and structure
Teilen und Aufbau

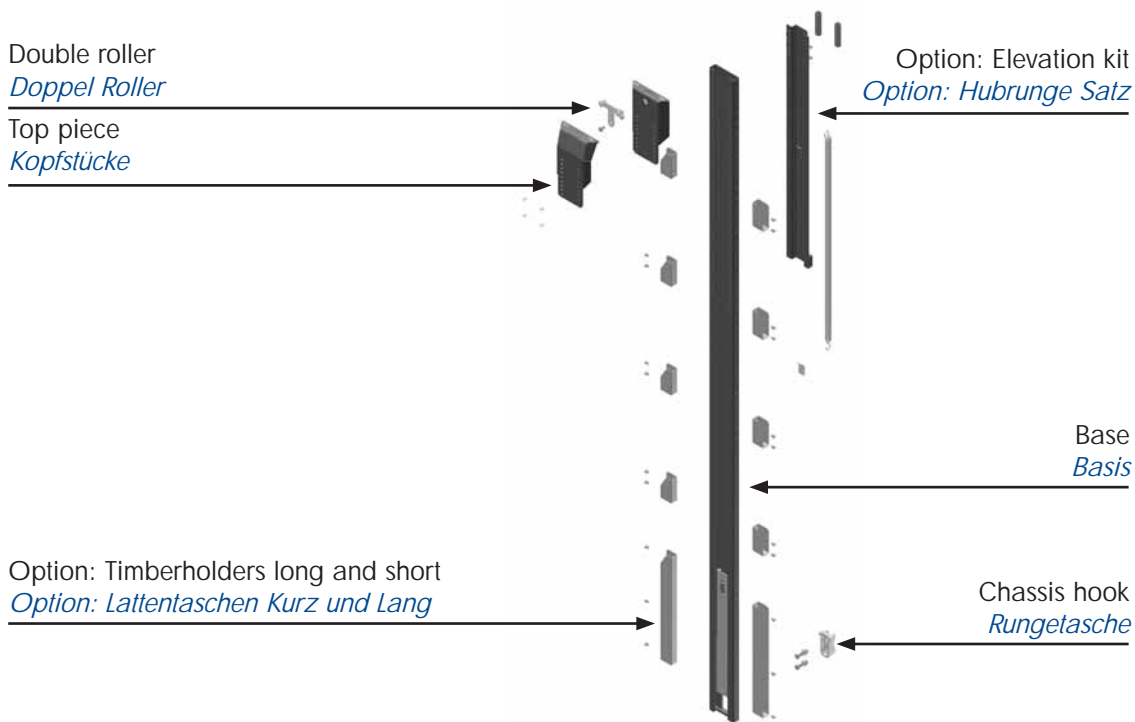

Basic elements LP3 pillar
Basisteile LP3 Runge

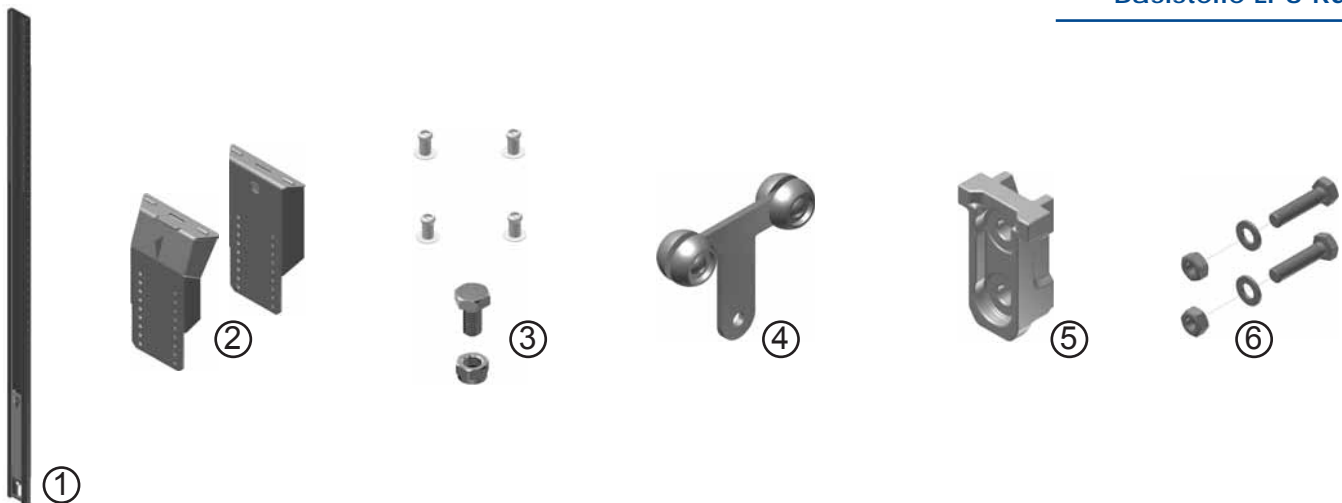

Basic elements LP2 pillar | Basisteile LP2 Runge

Description Umschreibung	Art. Nr.
1 Base LP3 - EN 12642 <i>Basis LP3 - EN 12642</i>	2803.001.1
2 Top piece <i>Kopfstück</i>	depends on the alu rail* abhängig alu Schiene*
3 Mounting kit for top piece <i>Montagesatz für Kopfstück</i>	2803.029.1
4 Double roller <i>Doppel Roller</i>	depends on the alu rail* abhängig alu Schiene*
5 Chassishook <i>Rungetasche</i>	2801.010.1
6 Mounting kit for chassishook <i>Montagesatz für Rungetasche</i>	2801.011.1

(*) see page 9 - *Sehe Pagina 9*

LIGHT PILLAR LP3

Ultra light sliding pillar

Parts and articlenumbers
Teilen und Artikelnummer

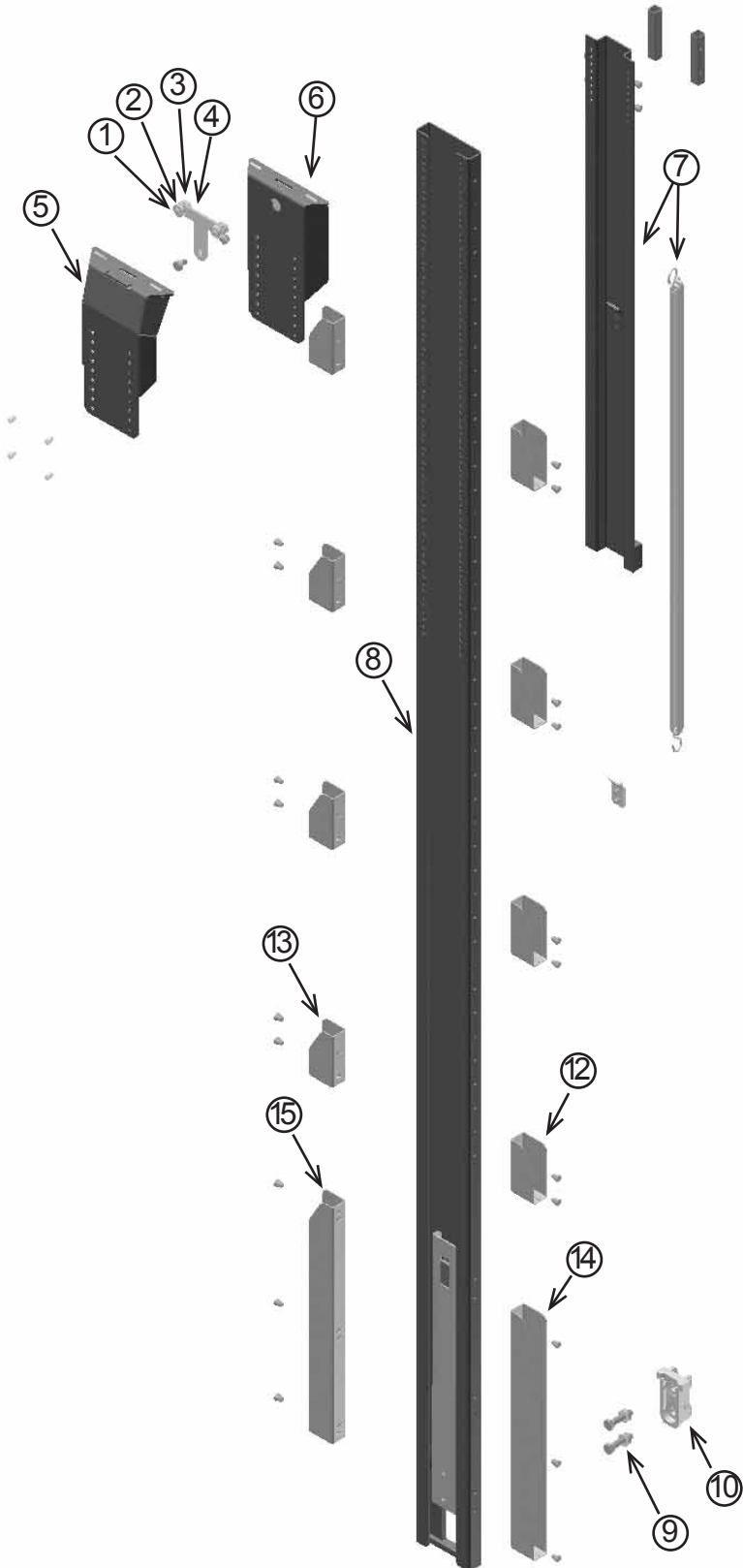

LIGHT PILLAR LP3

Ultra leichte Schieberunge

Basic elements LP3 - Light Pillar Basisteile LP3 - Light Pillar			
Nr	Art. Nr.	Description	Umschreibung
1	9000.056.1	Double roller Multiliner Combi & Slimliner - 20mm	<i>Doppel Roller Multiliner Combi & Slimliner - 20mm</i>
2	9000.058.1	Roller - 30mm/Multiliner High	<i>Roller - 30mm/ Multiliner High</i>
3	9000.055.1	Double roller /Multiliner Mix	<i>Doppel Roller /Multiliner Mix</i>
4	9000.057.1	Roller 50/40	<i>Roller 50/40</i>
5	2803.021.2	Top piece (Sesam Multiliner Mix)	<i>Kopfstücke (Sesam Multiliner Mix)</i>
6	2803.020.2	Top piece (Sesam Multiliner High + Slimliner)	<i>Kopfstücke (Sesam Multiliner High + Slimliner)</i>
	2803.029.1	Mounting kit top piece LP3	<i>Montage Satz Kopfstücke LP3</i>
8	2803.001.1	Light weighth pillar LP3	<i>Light weighth pillar LP3</i>
9	2801.011.1	Screw kit chassishook	<i>Schraubesatz Rungetasche</i>
10	2803.010.1	Chassishook	<i>Rungetasche</i>

Options LP3 - Light Pillar Option LP3 - Light Pillar			
Nr	Art. Nr.	Description	Umschreibung
7	2803.040.1	Elevation kit LP-3	<i>Hubrunge Satz LP-3</i>
12	2900.073.3	Timberholder right	<i>Rungetasche rechts</i>
13	2900.072.3	Timberholder left	<i>Rungetasche links</i>
14	2900.075.2	Timberholder large right	<i>Rungetasche groß rechts</i>
15	2900.074.2	Timberholder large left	<i>Rungetasche groß links</i>

© All rights belong to Edscha Trailer Systems GmbH, including patent rights applied for.
All rights of disposal such as copying and transfer rights be long to us. Please note copyright statement according to DIN 34! We reserve the right to make any changes in the interests of technical advancement.

© *Alle Rechte bei Edscha Trailer Systems GmbH, auch für Schutzrechtsanmeldungen.
Alle Verfügungsbefugnisse, wie Kopie- und Weitergaberechte bei uns. Schutzvermerk nach DIN 34 beachten!
Änderungen, die dem technischen Fortschritt dienen, behalten wir uns vor.*



Edscha Trailer Systems GmbH
Im Moerser Feld 1f
47441 Moers - Germany

Tel: +49 (0) 2841 60 70 700
Fax: +49 (0) 2841 60 70 333

info@EdschaTS.com
www.EdschaTS.com

Version G-CE~•c201G*

